



Welch Allyn® PanOptic™ Ophthalmoscope

118 Series

Instructions for use

REF 773581, DIR 80028102 Ver. A, Revision date: 2021-03

©2021 Welch Allyn, Inc.
Printed in the U.S.A.

Welch Allyn, Inc.
4341 State Street Road
Skaneateles Falls, NY 13153 USA

hillrom.com
Welch Allyn, Inc. is a subsidiary of Hill-Rom Holdings, Inc.

Authorized Australian Sponsor
Welch Allyn Australia Pty. Ltd.
Unit 4.01, 2-4 Lyonpark Road
Macquarie Park, NSW 2113
Phone 1800 650 083

Symbols

WARNING The warning statements in this manual identify conditions or practices that could lead to illness, injury, or death. Warning symbols will appear with a grey background in a black and white document.

CAUTION The caution statements in this manual identify conditions or practices that could result in damage to the equipment or other property, or loss of data.

NOTE Presents clarification about an instruction or helpful information about a feature or behavior.

Type BF applied part

Product Identifier

Reorder number

Manufacturer

Prescription only or "For use by or on the order of a licensed medical professional"

Consult Instructions for use

Lot code

Global Trade Item Number



Warnings and cautions

WARNING The light emitted from the ophthalmoscope is potentially hazardous. The longer the duration of exposure, the greater the risk of ocular damage. Exposure to light from this instrument, when operated at maximum intensity, will exceed the safety guideline after 13 minutes when lit with a LED lamp (blue base). Exposure times are cumulative for a 24-hour period.

WARNING When using Halogen illumination, no acute optical radiation hazards are identified. However, Welch Allyn recommends limiting the intensity of the light directed into the patient's eye to the minimum level that is necessary for diagnosis. Infants, aphakes, and persons with diseased eyes are at a greater risk. The risk is also increased if the examined person has had any exposure with the same instrument or any other ophthalmic instrument using a visible light source within the previous 24 hours. This will apply particularly if the eye has had exposure to retinal photography. The intended use of this device is for routine ophthalmic exams on the order of typically less than 60 seconds per eye. Although there is a benefit versus risk factor in any medical procedure, these more complicated exams should not exceed a three minute exam time in 24 hours. Significant use of this device beyond its intended use is not recommended; it may cause harm to the eyes.

WARNING To minimize lamp housing temperatures, on-time should not exceed 2 minutes with off-time not less than 10 minutes.

WARNING Use only PanOptic Patient Eyecups with this product.

WARNING Rx only (for professional use).

WARNING Lamps may be hot. Lamp should be allowed to cool before removal.

WARNING Equipment not suitable for use in the presence of a flammable anesthetic.

CAUTION Halogen lamps are pressurized to provide maximum efficiency and illumination. Mistreatment may cause shattering. Protect lamp surface against abrasion and scratches. Verify power is off when replacing lamp. Dispose of lamp with care.

NOTE A graph of the relative spectral output of the instrument is available upon request.

The PanOptic™ Ophthalmoscope

Transparency of the cornea, lens and vitreous humor permits the practitioner to directly view arteries, veins, and the optic nerve of the retina.

Direct observation of the structures of the fundus through a PanOptic Ophthalmoscope may show disease of the eye itself or may reveal abnormalities indicative of disease elsewhere in the body. Among the most important of these are vascular changes due to diabetes or hypertension and swelling of the optic nerve head due to papilledema or optic neuritis. In this sense, the eye serves as a window through which many valuable clinical evaluations may be made.

When a preliminary diagnosis of an imminently dangerous eye condition, such as acute (angle-closure) glaucoma or retinal detachment, is made by the examiner, prompt referral to an eye specialist may prevent irreversible damage. Or, when distressing but less urgent conditions, such as visual impairment due to cataract or vitreous floaters, are recognized, the patient can be reassured and referred.

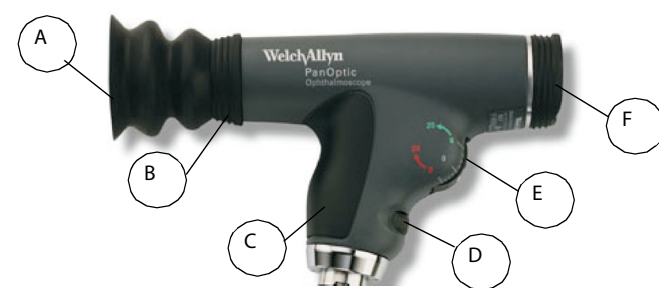

A	patient eyecup	D	aperture/filter dial
B	patient's side	E	focusing wheel
C	soft grip handle	F	practitioner's side brow rest

Set-up instructions

Attach the PanOptic Ophthalmoscope head to a Welch Allyn power source

- Align cutouts in the PanOptic Ophthalmoscope base with lugs on power source. (The PanOptic Ophthalmoscope fits all 3.5v Welch Allyn power sources.)
- Push in slightly and turn 90 degrees.

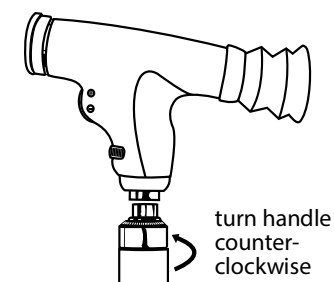

Attach the patient eyecup to the PanOptic

WARNING Use only PanOptic Patient Eyecups with this product.

- Insert eyecup into the patient's side of the instrument.
- Push and twist in one motion until you feel the two "lock" together.

See Accessory and replacement parts list to reorder new PanOptic Patient Eyecups.

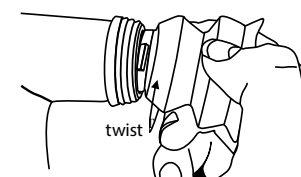

Attach the corneal viewing lens to the PanOptic (model 11820 only)

- Insert Corneal Viewing Lens into patient's side of the instrument.
- Push and twist in one motion until you feel the two "lock" together as shown, except replacing Patient Eyecup with the Corneal Viewing Lens.
- Verify that the line on the lens housing is aligned with the top seam of the PanOptic instrument.

Conduct an examination with the PanOptic Ophthalmoscope

- To examine the right eye, stand or sit to the patient's right side.
- Remove spectacles (preferred, but not required) (A).
- Look through the scope (from the doctor's side) with your thumb on the focusing wheel. Focus the scope on an object roughly 15 feet away. (This procedure will make any adjustments for your own eye's corrective needs.) (B)
- Start with the small aperture (green line position on the aperture dial). (C)
- Turn the scope on (using any Welch Allyn 3.5V power source). Adjust light intensity rheostat to desired position. (D)
You are now ready to begin the examination:
- Examiner should be positioned approximately 15 degrees to the temporal side of the patient. (E)
- Instruct the patient to look straight ahead at a distant object.
- Begin from about 6 inches away, looking through the scope and shining the light at the patient's eye while looking for the red retinal reflex. (F)
- Rest your left hand on the patient's forehead. (optional)
- Slowly follow the red reflex toward the patient and into the pupil. Get as close as possible for the optimum view (the eyecup should contact the patient's brow). (G)
- Once you have a stable view of the fundus rotate the focusing wheel until you have a crisp view of the optic disc and the vessels surrounding it.

NOTE For the largest view, compress the eyecup halfway against the patient's brow. This enables the user to view the entire optic disc plus many surrounding vessels (about 25° field of view) at one time. (H)

- Examine the optic disc for clarity of outline, color, elevation and condition of the vessels. Follow each vessel as far to the periphery as you can. To locate the macula, focus on the disc, then move the light approximately one (1) disc diameter temporally. You may also have the patient look at the light of the ophthalmoscope, which will automatically place the macula in full view. Examine for abnormalities in the macular area. The red-free filter facilitates viewing of the center of the macula, or the fovea. (I)

- To examine the extreme periphery instruct the patient to:
 - look up for examination of the superior retina
 - look down for examination of the inferior retina
 - look temporally for examination of the temporal retina
 - look nasally for examination of the nasal retina.

This routine will reveal almost any abnormality that occurs in the fundus.

- To examine the left eye, repeat the procedure outlined above. However, unlike traditional ophthalmoscopy, a unique feature of PanOptic is that the examiner does not have to switch to his/her left eye. The practitioner can use either eye to examine either patient eye because of the greater working distance between patient and practitioner. This permits those who are strongly dominant in one eye to always use that eye in the fundus exam. (J)

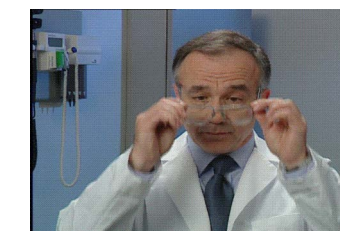

(A)



(B)



(C)



(D)



(E)



(F)



(G)



(H)

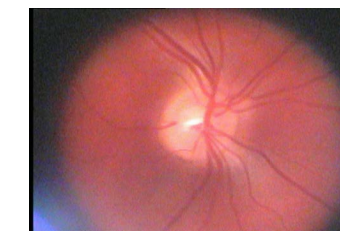







(I)



(J)

Apertures and filters

There is a wide range of practical apertures and filters to select from: small spot, large spot, micro spot, slit aperture, red-free filter, cobalt blue filter (optional), and half-moon aperture (optional).

- Small aperture:** Provides easy view of the fundus through an undilated pupil. Always start the examination with this aperture and proceed to micro aperture if pupil is particularly small and/or sensitive to light. This position is the "Home" position on the aperture dial and is denoted by the green marking. 
- Large aperture:** Standard aperture for dilated pupil examination of the eye. 
- Micro spot aperture:** Allows easy entry in very small, undilated pupils. 
- Slit aperture (models 11810, 11820 only):** Helpful in determining various elevations of lesions, particularly tumors and edematous discs. 
- Red-free filter (model 11810, 11820 only):** This filter excludes red rays from the examination field: this is superior to ordinary light in viewing slight alterations in vessels, minute retinal hemorrhages, ill-defined exudates and obscure changes in the macula. The nerve fibers become visible and the observer may note the disappearance of such fibers, as in optic nerve atrophy. The background appears gray, the disc appears white, the macula appears yellow, the fundus reflex is intense and the vessels appear almost black. This filter is also used to help distinguish veins from arteries; veins stay relatively blue, but oxygenated arterial blood makes arteries appear blacker. This greater contrast makes differentiation easier for the examiner. 
- Cobalt blue filter (model 11820 only):** In conjunction with fluorescein dye applied topically to the cornea and an add-on magnifying lens (included), this filter is helpful in detecting corneal abrasions and foreign bodies. In this way, it can be used as a surrogate to a Woods Light. 
- Half-moon aperture (11810 only):** Provides a combination of depth perception and field-of view. 

The eye

In addition to examination of the fundus, the PanOptic Ophthalmoscope is a useful diagnostic aid in studying other ocular structures. The light beam can be used to illuminate the cornea and the iris for detecting foreign bodies in the cornea and irregularities of the pupil.

The practitioner can also easily detect lens opacities by looking at the pupil through an add-on corneal viewing lens. In the same manner, vitreous opacities can be detected by having the patient look up and down, to the right and to the left. Any vitreous opacities will be seen moving across the pupillary area as the eye changes position or comes back to the primary position.

- A) macula
- B) vitreous humor
- C) sclera
- D) choroid
- E) retina
- F) ora serrata
- G) canal of schlemm
- H) anterior chamber
- I) iris
- J) cornea
- K) ciliary body
- L) zonule (suspensory ligament)
- M) conjunctiva
- N) lens
- O) hyaloid canal
- P) central retinal vein
- Q) optic nerve
- R) central retinal artery

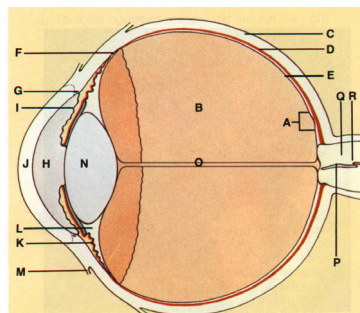

Lamp replacement instructions

WARNING: Lamps may be hot. Lamp should be allowed to cool before removal. **Use only Welch Allyn model 03800-U or 03800-LED lamps with this product.**

CAUTION: Halogen lamps are pressurized to provide maximum efficiency and illumination. Mistreatment may cause shattering. Protect lamp surface against abrasion and scratches. Verify power is off when replacing lamp. Dispose of lamp with care.

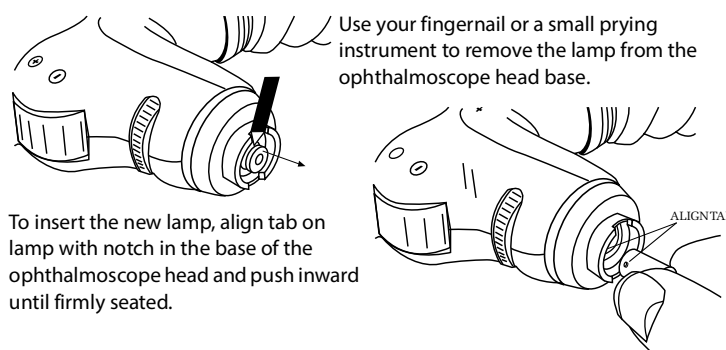

To insert the new lamp, align tab on lamp with notch in the base of the ophthalmoscope head and push inward until firmly seated.

Repairs

Repairs should be performed at the factory.

Cleaning and disinfection

Lenses: PanOptic is a precision optical instrument. Do not use any solvent-based cleaners on the lenses. Use only a clean optical grade cloth to clean the lenses.

Housing: Wipe the PanOptic housing with an appropriate health care low- or intermediate-level cleaner/disinfecting wipe that incorporates either a 1:10 sodium hypochlorite (bleach) solution or isopropyl alcohol as the active disinfection ingredient. Follow wipe manufacturer's instructions for appropriate use, contact times and applicable warnings and precautions.

Do not excessively saturate the PanOptic. Do not immerse PanOptic in any solution.

Do not sterilize the PanOptic.

After disinfection, inspect the PanOptic for visible signs of deterioration. If evidence of damage or deterioration is present, discontinue use and contact Welch Allyn or your area representative.

Patient eyecup: Wipe the Patient Eyecup with an appropriate health care low- or intermediate-level cleaner/disinfecting wipe that incorporates isopropyl alcohol as the active disinfection ingredient or soak in a glutaraldehyde-based solution. Follow product manufacturer's instructions for appropriate use, contact times and applicable warnings and precautions.

Patient Eyecup can be autoclaved.

Do not use acetone based products or other harsh chemicals.

No other preventative maintenance is necessary for this product.

Troubleshooting

Trouble area	Possible cause	Corrective action
No Light output	Aperture dial is in-between positions.	Rotate the aperture dial.
	Lamp burned out.	Replace the lamp using Welch Allyn part number 03800-U or 03800-LED.
	Wrong lamp/ incorrect Welch Allyn lamp/non-Welch Allyn lamp.	Replace the lamp using Welch Allyn part number 03800-U or 03800-LED.
	The battery handle has completely discharged.	Charge the handle, check the battery, and/or the charger.

Trouble area	Possible cause	Corrective action
Spot is not centered.	The aperture dial is not centered.	Move aperture dial to the full detent position.
Not achieving full or expected view.	Unit is not in proper operating position.	Ensure that the eyecup is slightly compressed during the procedure.
Can not obtain sharp focus/hazy view.	The lenses are dirty.	Clean the lenses with a clean/soft optical grade cleaning cloth.
Dim Light Output	Lamp pin not engaged in slot.	Insert the lamp with pin firmly seated in slot.
	Film on Optics	Clean the lenses with a clean/soft optical grade cleaning cloth.
	The handle is not fully charged.	Charge the handle, check the battery and/or the charger.
Glare in view	Fingerprints or dirt on the objective (Patient's Side) lens.	Clean the objective (Patient's Side) lens with a clean/soft optical grade cleaning cloth.
Cannot attach to power handle.	Lamp is not fully inserted.	Insert the lamp with pin firmly seated in slot.

Accessory and replacement parts list

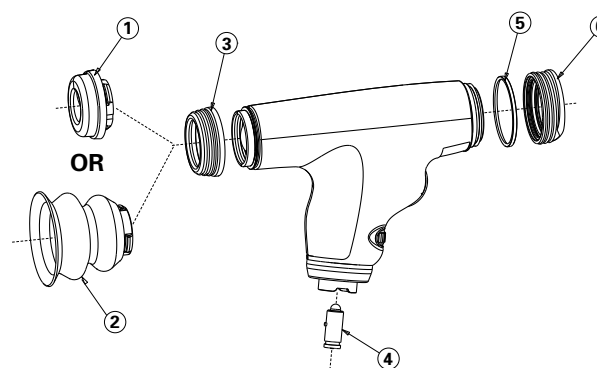

Item no.	Description	Product no.
1	Corneal Viewing Lens (model no. 11820 only)	11875
2	Patient Eyecups (Package of five (5) each 118092)	11870
3	Patient's Side Bumper	118051
4	Lamps	03800-U or 03800-LED
5	Chrome Ring	118027
6	Practitioner's Side Brow Rest	118052

PATENT/PATENTS

hillrom.com/patents

May be covered by one or more patents. See above Internet address. The Hill-Rom companies are the proprietors of European, US, and other patents and pending patent applications.

Hillrom Technical Support

For information about any Hillrom product, contact Hillrom Technical Support at hillrom.com/en-us/about-us/locations

Specifications

Model number

11810 PanOptic Ophthalmoscope without Cobalt Blue Filter
11820 PanOptic Ophthalmoscope with Cobalt Blue Filter and Add-on Corneal Viewing Lens

Dimensions

5.125"L x 1.4"W x 3.750"H without eyecup
Eyecup 1.45"L

Weight

.48 lbs without eyecup
.50 lb with eyecup

Equipment Classification

IPX0 Equipment not protected against the ingress of water.

Environment
Temperature limitation
Operating: 59 °F (10 °C) -104 °F (49 °C)
Transport/storage: -4 °F (-20 °C) - 120 °F (55 °C)

Humidity limitation
Operating: 30% - 90%
Transport/storage: 10% - 95%

Atmospheric pressure limitation
500 hPa - 1060 hPa

Standards and compliance

IEC/UL/CSA/EN 60601-1
ISO 10943

PanOptic Ophthalmoscope Warranty

Welch Allyn, Inc. warrants the No. 11810, 11820 PanOptic Ophthalmoscope to be free of original defects in material and workmanship and to perform in accordance with manufacturer's specifications for a period of one year from the date of purchase. If this instrument or any component thereof is found to be defective or at variance with the manufacturer's specifications during the warranty period, Welch Allyn will repair or replace the instrument or component(s) at no cost to the purchaser.

This warranty only applies to instruments purchased new from Welch Allyn or its authorized distributors or representatives. The purchaser must return the instrument directly to Welch Allyn or an authorized distributor or representative and bear the costs of shipping.

This warranty does not cover breakage or failure due to tampering, misuse, neglect, accidents, modification or shipping, and is void if the instrument is not used in accordance with manufacturer's recommendations or if repaired or serviced by other than Welch Allyn or a Welch Allyn authorized representative.

No other express or implied warranty is given.